



**PRODUCT DATASHEET**  
**I-14DD OVERHEAD SECTIONAL**  
**DIRECT DRIVE DOOR**

# Copyright and Disclaimer Notice

Although the contents of this publication have been compiled with the greatest possible care, ASSA ABLOY cannot accept liability for any damage that might arise from errors or omissions in this publication. We also reserve the right to make appropriate technical modifications/replacements without prior notice.

No rights can be derived from the contents of this document.

Color guides: Color differences may occur due to different printing and publication methods.

Dynaco as word and logo are trademarks belonging to the ASSA ABLOY Group.

No part of this publication may be copied or published by means of scanning, printing, photocopying, microfilm or any other process whatsoever without prior permission in writing by ASSA ABLOY.

© ASSA ABLOY 2006-2023.

All rights reserved.

# Technical Overview

## Features

Max size: (W x H)	4050 x 4250 mm Note: Maximum door size determined by maximum door weight of 200kg
Panel thickness:	42 mm
Panel material:	Microrilled steel
Filling:	CFC-free polyurethane, flame retardant DIN 4102-B2
Weight	13 kg/m <sup>2</sup>
Color outside:	13 standard RAL colors
Color inside:	RAL 9002
Track types:	Standard: SL Optional: HL, VL
Windows:	Optional: DARP, TARP, DAOP, ALRB, ALBS, Framed section
Passdoor:	Optional
Electrical operation:	Automated operation, Access control, Safety functions

## Performance

Opening/closing speed:	0,17 m/s	
Life time expectations:	Door: 200000 door cycles or 10 years, when service/replacement program has been performed Motor: 50000 door cycles	
Resistance to wind load, EN12424	Insulated panel sections	Class 3 (Higher classes on request)
	Framed sections nr. 2 and 3	Class 3 (DLW ≤ 3650); Class 2 (3650 < DLW ≤ 4050)
Thermal transmittance, EN12428	1,1 W/(m <sup>2</sup> K) full panel (Door size 4050 x 4250 mm)	
	1,0 W/(m <sup>2</sup> K) full panel (Door size 5000 x 5000 mm)	
Resistance to Water penetration, EN12425	Class 3	
Air permeability, EN12426	Class 3	
Acoustic insulation, EN ISO 10140-2	R - 25 dB	

# Contents

Copyright and Disclaimer Notice.....	2
Technical Overview.....	3
<b>1 Description.....</b>	<b>6</b>
1.1 General.....	6
1.2 Dimensions.....	6
1.2.1 Daylight width and daylight height.....	6
1.2.2 Section sizes.....	6
1.3 Door leaf.....	7
1.3.1 Construction.....	7
1.3.2 Material.....	7
1.3.3 Vertical cross-section.....	8
1.3.4 Colors.....	8
1.3.5 Seals.....	9
1.3.6 Wind reinforcement truss.....	9
1.3.7 Handle.....	10
1.3.8 Lock bolt.....	10
1.4 Track sets.....	10
1.4.1 General.....	10
1.4.2 SL - Standard Lift.....	10
1.4.3 HL - High Lift.....	11
1.4.4 VL - Vertical Lift.....	11
<b>2 Available Options.....</b>	<b>12</b>
2.1 Passdoor with standard threshold (180 mm).....	12
2.2 Passdoor standard threshold (180mm).....	13
2.3 Fixed sections.....	13
2.3.1 Fixed sections options.....	13
2.4 Windows.....	14
2.4.1 DARP.....	14
2.4.2 TARP.....	14
2.4.3 DAOP.....	15
2.4.4 ALRB.....	15
2.4.5 ALBS.....	15
2.4.6 Protective grating.....	15
2.4.7 Frame section.....	15
2.4.8 Number of windows.....	16
2.4.9 Windows.....	16
2.5 Optional colors*.....	17
2.6 Locks.....	17
2.6.1 Cylinder lock.....	17
2.7 Anti corrosive hardware.....	18
2.8 Collision protection.....	18
2.8.1 Track protection kit.....	18
2.8.2 Reinforced bottom profile.....	18
<b>3 Operating system.....</b>	<b>19</b>
3.1 Type of operation.....	19
3.2 Electrical operation.....	19
3.3 TS 971XL Door control.....	19
3.4 SI 16.20-SW32,1 Operator.....	20
3.5 Guidelines for automation.....	20
3.6 Access and automation.....	21
3.6.1 Basic control functions.....	21
3.6.2 External control functions.....	21
3.6.3 Automatic control functions.....	21
3.6.4 Safety functions.....	22
3.6.5 Additional functions.....	22

<b>4</b>	<b>CEN Performance</b> .....	<b>23</b>
4.1	Lifetime expectation .....	23
4.2	Resistance to windload .....	23
4.3	Resistance to water penetration .....	23
4.4	Air permeability .....	23
4.5	Thermal transmittance .....	24
4.6	Acoustic insulation .....	24
4.7	Operating forces and safe openings .....	24
<b>5</b>	<b>Building and space requirements</b> .....	<b>25</b>
5.1	Building preparations .....	25
5.1.1	Installation preparations .....	25
5.2	Space requirements .....	25
5.2.1	Space requirements SL .....	26
5.2.2	Space requirements HL .....	27
5.2.3	Space requirements VL .....	28
5.2.4	Space requirements Door operators .....	29
	<b>Index</b> .....	<b>30</b>

# 1 Description

## 1.1 General

The Dynaco I-14DD overhead sectional direct drive door, with its modern, clean design, is one of the most stable and well insulated overhead doors on the market.

It is an overhead sectional door, suitable for all types of buildings, with regard to both function and appearance. High flexibility makes it possible to install this door in almost every type of building.

The door slides up under the roof when opened, allowing free space around the door opening and leaving the door opening completely free.

The door is made of insulated panels. These panels are designed without thermal bridge to provide minimal thermal transmittance, which reduces energy cost.

The Dynaco I-14DD overhead sectional direct drive door has been designed to meet all operational and safety requirements in the European Directives and the standards issued by the European Standardization Committee, CEN.



The door has 3 primary parts:

1. Door leaf
2. Track set
3. Operating system

## 1.2 Dimensions

### 1.2.1 Daylight width and daylight height

The standard Dynaco I-14DD overhead sectional direct drive door is delivered in the following size range:

	Daylight width	Daylight height
Min.:	1200 mm	1936 mm
Max.:	4050 mm	4250 mm

Note: Maximum door size determined by maximum door weight of 200kg.

### 1.2.2 Section sizes

Section height:	545 mm
Top section height:	275 - 820 mm trimcut
Thickness:	42 mm

The door leaf height is achieved by trimcutting the top section.

## 1.3 Door leaf

### 1.3.1 Construction

The Dynaco I-14DD overhead sectional direct drive door leaf has horizontal sections, connected together with hinges. The outer hinges of each section have rollers that run in the tracks. The horizontal sections are insulated panels designed without thermal bridges for optimal insulation. The panels are filled with water blown CFC-free polyurethane.

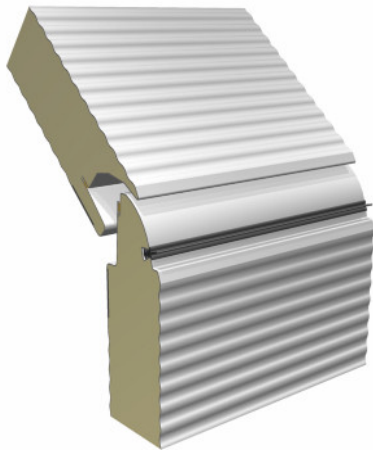

### 1.3.2 Material

The surface of the door leaf panels is characterized by the microrilled steel sheet. The pre-coated steel panels (steel pre-coated) for the door leaf fulfill outdoor corrosion resistance category RC3 according to EN 10169.

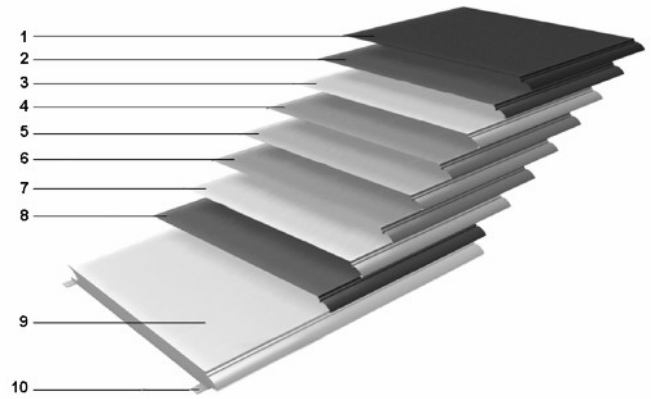

1. Polyester coating
2. Primer
3. Chromate layer
4. Zinc based metallic coating\*
5. Steel sheet
6. Zinc based metallic coating\*
7. Chromate layer
8. Primer
9. CFC-free polyurethane (water blown), Flame retardant DIN4102-B2
10. Reinforcement strips

### 1.3.3 Vertical cross-section

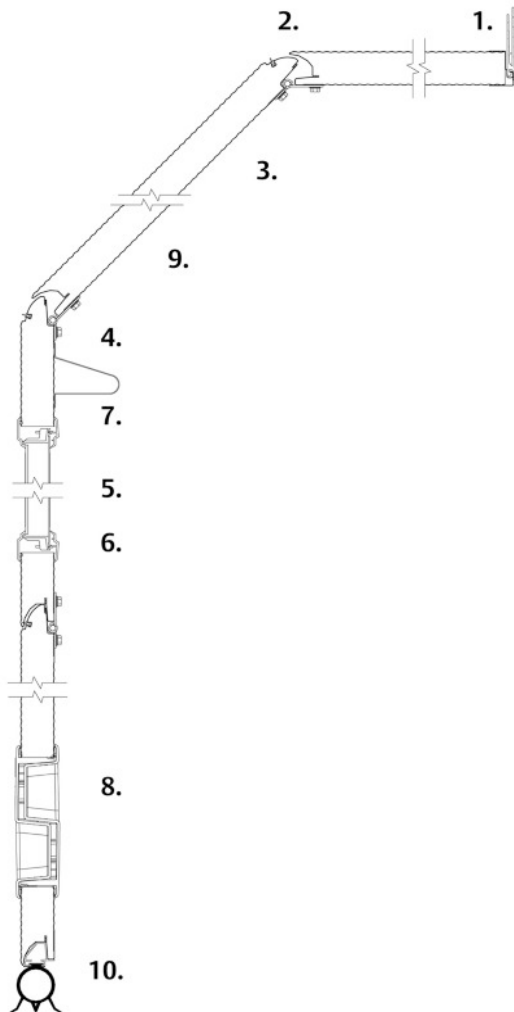

1. Top seal
2. Section joint with finger pinch protection and seals
3. Inner and outer sheet
4. Internal steel reinforcement, to provide positive fixing points
5. Window (optional)
6. High impact polystyrene frame
7. Panel truss - wind reinforcement (if necessary)
8. Step/lift handle
9. Insulation (CFC-free / water blown)
10. Bottom seal

### 1.3.4 Colors

The RAL-colors are as close as possible to the official RAL HR collection. Max. deviation is 1,0 DE (RAL 7016 excluded).

Pre-coated range:

	RAL 1021
	RAL 3000
	RAL 5010
	RAL 6005
	RAL 7016
	RAL 7021
	RAL 7024
	RAL 8017
	RAL 9002
	RAL 9005
	RAL 9006
	RAL 9007
	RAL 9010

#### 1.3.4.1 Pre-coated colors

- Outside color: The steel panel is available in the 13 standard RAL colors
- Inside color: RAL 9002 - Grey white.



### 1.3.5 Seals

The door is equipped with well designed seals on all sides that gives the door its excellent sealing abilities.

#### 1.3.5.1 Top seal

Installed on the top panel to seal the gap between the panel and the wall. The double lip EPDM rubber top seal is mounted in an ABS adapter profile for optimal insulation and tightness.

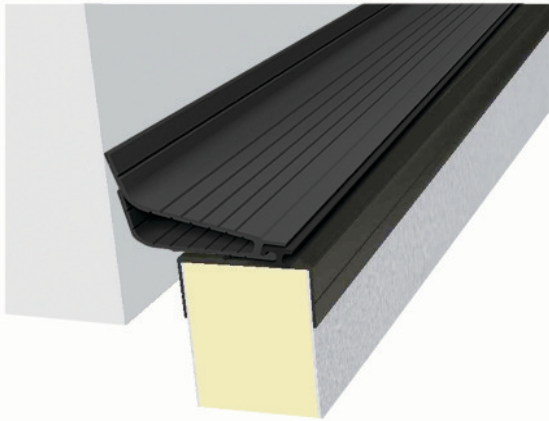

#### 1.3.5.2 Side seal

Installed on the track set to close the gap between the tracks and the door leaf. The double lip side seal design with insulation chambers ensures an optimal insulation and sealing.

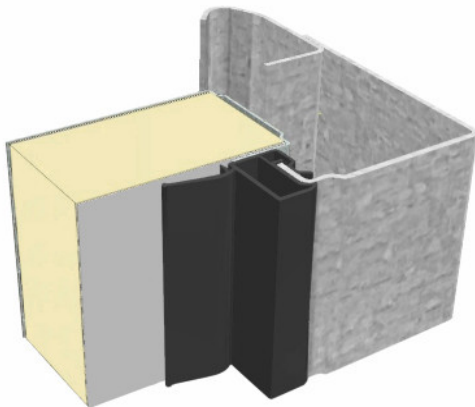

#### 1.3.5.3 Bottom seal

Installed on the bottom edge of the bottom panel, to act as a barrier as well as a shock absorber. The flexible EPDM rubber material and the O-shape provides continuous pressure on the floor, ensuring maximum sealing. The bottom seal is mounted in an ABS adapter for optimal insulation and reduced risk of condensation.

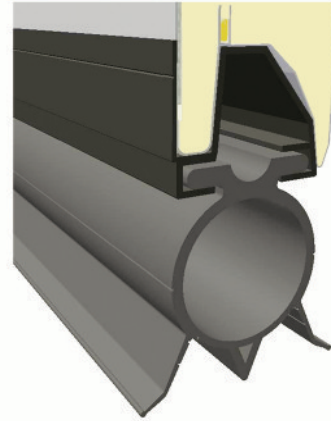

### 1.3.6 Wind reinforcement truss

Wider door panels and panels with windows are reinforced with metal profiles that act as trusses. These trusses reduce bending of the panel caused by wind loads or when the door leaf is in the horizontal position and is bending under its own weight. The truss is sloped to prevent objects being placed on it which could fall when the door opens. Nice plastic endcaps prevent dust being collected in the truss.

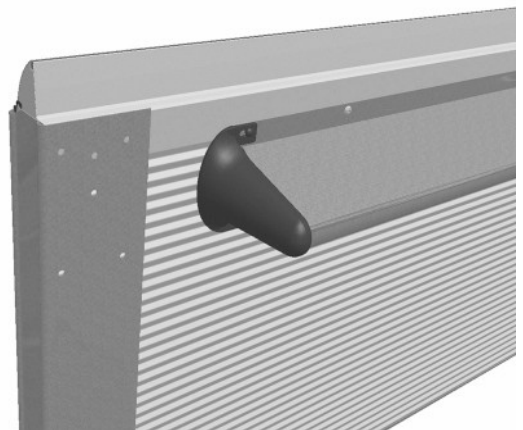

### 1.3.7 Handle

Every Dynaco I-14DD overhead sectional direct drive door is provided with a solid, easy to grip and step-on handle.

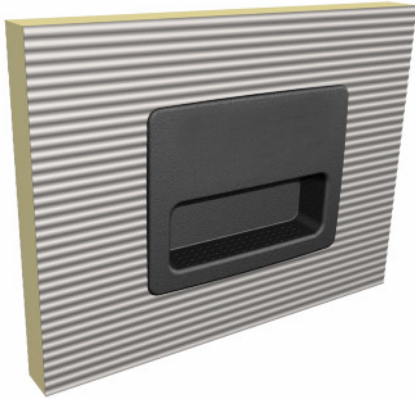

### 1.3.8 Lock bolt

A standard Dynaco I-14DD overhead sectional direct drive door is equipped with a lock bolt. The lock bolt locks the door from the inside, without the use of a key. The lock bolt has a hole in the latch, to allow the use of a 12mm padlock.

The lock bolt is not visible from the outside.

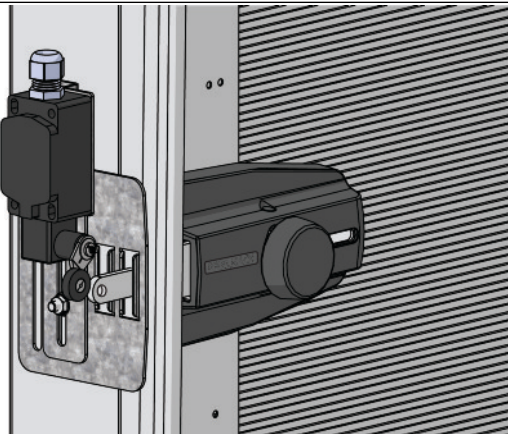

## 1.4 Track sets

### 1.4.1 General

The track set supports the door leaf on its rollers and guides it upwards. The selection of the appropriate track set is based on various factors:

- Available head room
- Door height
- Type of vehicles
- Presence of roof obstructions, pipes and overhead crane beams.

The track sets below cover most applications. Other applications are available on request.

### 1.4.2 SL - Standard Lift

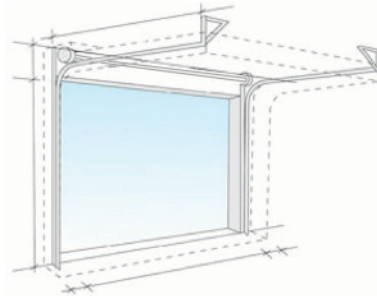

- Building type: Most standard industrial buildings.
  - Benefits: Optimal design for common buildings.
- The Standard Lift track set, with the lifting mechanism just above the door, is the most common solution.

### 1.4.3 HL - High Lift

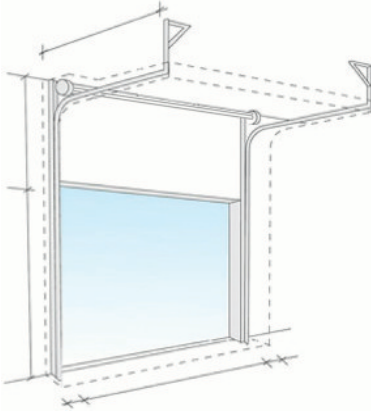

- Building type: High ceilings. On the High Lift track set the lifting mechanism is placed high above the door.
- Benefits: This track type allows high vehicles to cross along the door opening without obstructions of the horizontal tracks.

This track type is used when the space above the door is considerable, and is needed for work and traffic, e.g.: high vehicles.

### 1.4.4 VL - Vertical Lift

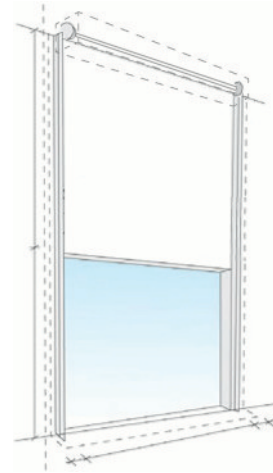

- Building type: Very high ceiling and high working space requirements.
- Benefits: Allows high vehicles to cross along the door opening without any obstructions.

If the space between the daylight height and the roof is sufficient, with this track type, the door can be opened vertically.

## 2 Available Options

### 2.1 Passdoor with standard threshold (180 mm)

The standard 180 mm is designed to be combined with virtually all options of the door. It is not applicable as an emergency exit, with a threshold of 180 mm.

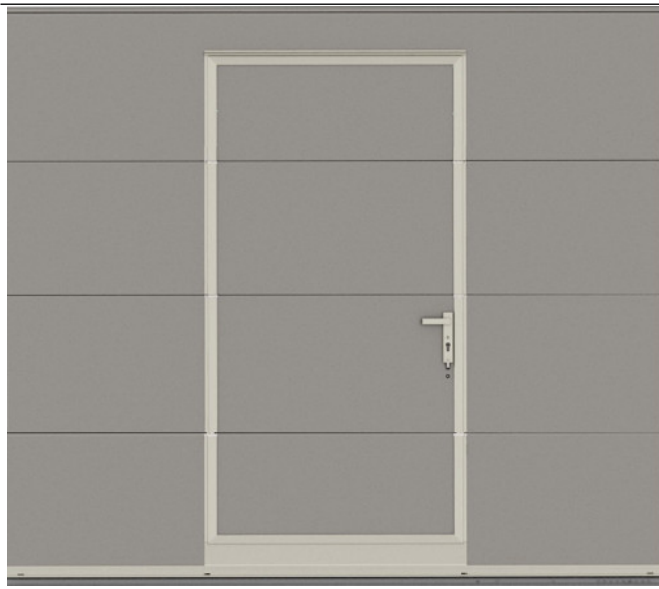

#### Features:

- 900/1200 mm free passing space
- Minimum free passing height 2056 mm
- Always opening outwards, min. 90 degrees opening
- Hinged left or right
- Improved insulation through thermal separation in profiles
- Double seals in passdoor frame minimize air/water permeability and increase overall insulation properties
- Integrated passdoor switch if electrically operated
- Aluminium door handle
- All commonly used cylinder locks are available:  
Euro, Keso. Standard : Euro cylinder lock
- High quality door closer with hold open function
- Panic lock (option)
- Multipoint lock (option)
- Minimum DLH 2261 mm
- Prepared for IoT (remote locking and monitoring)

#### Construction

This passdoor is constructed with the standard bottom section and bottom seal. A reinforcement truss on the bottom section is required to maintain the door's sturdiness and resistance to wind load.

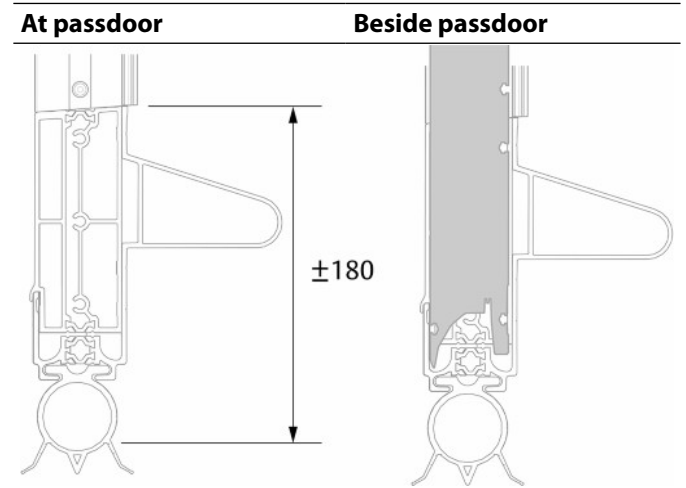

#### Outside view of threshold



## 2.2 Passdoor standard threshold (180mm)

### Passdoor opening sizes

Width:	900/1200 mm
Height from floor level:	2090 mm

### Position of passdoor \*

Daylight width	Pane no.
2050 - 2299 mm	1
2300 - 3264 mm	1 or 2
3265 - 4229 mm	2
4230 - 5194 mm	2 or 3
5195 - 6050 mm	3

\* Position and opening direction of the passdoor depend on the total door width and glass weight. For detailed information contact your local sales team.

### Permissible overhead door sizes

Minimum permissible DLW	2050 mm
Maximum permissible DLW	6050 mm
Minimum permissible DLH	2261 mm
Maximum permissible DLH	6050 mm

### Specifications

Threshold height:	180 mm incl. bottom seal
Lock:	Depends on market

## 2.3 Fixed sections

Fixed sections can advantageously fill space around new doors that are smaller than the wall opening. Fixed sections are available in top and side sections, with or without windows or passdoor. Fixed sections are supplied in the same color and construction as the door leaf.

A fixed section can be provided with a passdoor for two reasons: Safety and energy cost reduction.

- Safety: Putting a separate passdoor in a fixed section next to the industrial door separates pedestrian and vehicle traffic.
- Energy cost reduction: The opening space for frequent pedestrian traffic is minimized.

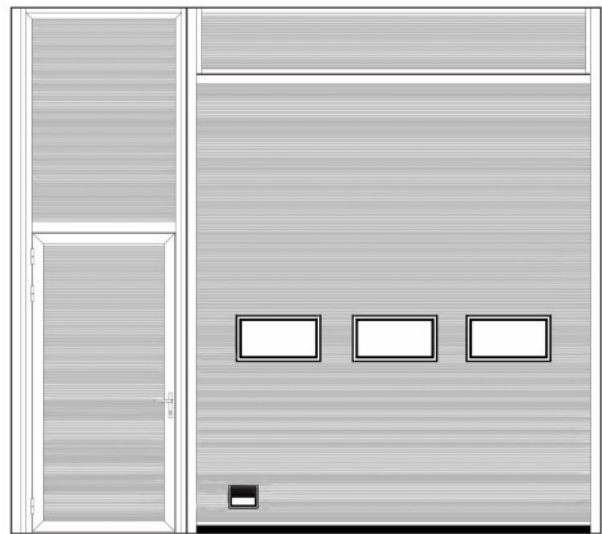

### 2.3.1 Fixed sections options

	Minimum size in mm (Daylight width - Daylight height)
Passdoor	800 - 2076
Side panel with passdoor (A)	800 - 2441
Side panel with passdoor (B)	1496 - 2076
Side panel with passdoor (C)	1496 - 2441
Side panel without passdoor	300 - 300
Side panel without passdoor (loose sections)	83 - 140
Top panel (loose sections)	83 - 83

	Maximum size in mm (Daylight width - Daylight height)
Passdoor	1495 - 2440
Side panel with passdoor (A)	1495 - 6000
Side panel with passdoor (B)	2400 - 2076
Side panel with passdoor (C)	2400 - 6000
Side panel without passdoor	2400 - 6000
Side panel without passdoor (loose sections)	8000 - 6000
Top panel (loose sections)	8000 - 6000

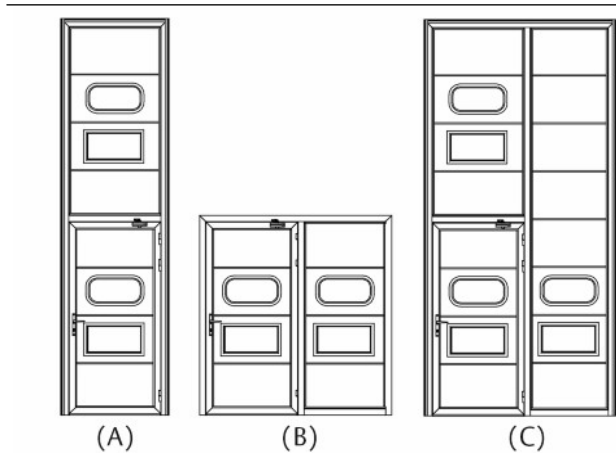

B - C available on request

## 2.4 Windows

The door sections can be glazed with windows\*. The number of windows per section is directly related to the daylight width. Optionally, one single window can be placed on the outer left or right side, in the third section.

\*The bottom section cannot be glazed.

### 2.4.1 DARP

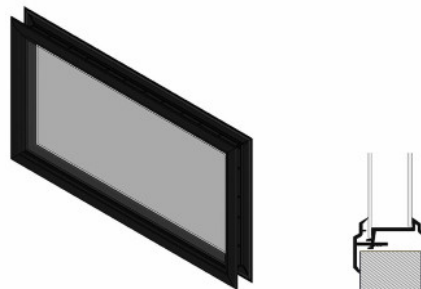

- Double layer Acrylic (3 + 2 mm), Rectangular, in Plastic frame
- Light opening: 604 x 292 mm
- Window frame: Black

### 2.4.2 TARP

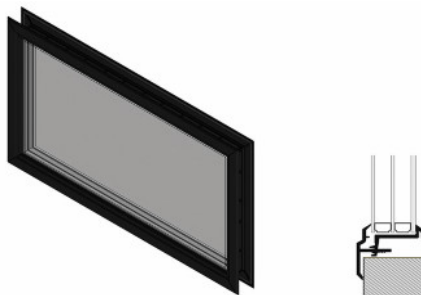

- Three layer Acrylic (3 + 3 + 2 mm), Rectangular, in Plastic frame
- Light opening: 604 x 292 mm
- Window frame: Black

### 2.4.3 DAOP



- Double layer Acrylic (3 + 2 mm), Oval, in Plastic frame
- Light opening: 610 x 292 mm
- Window frame: Black

### 2.4.4 ALRB



- Aluminum Layer Rectangular Burglar, double layer (6+6 mm) in aluminum frame
- Light opening: 578,5 x 268,5 mm
- Burglar Resistance Class 2

### 2.4.5 ALBS



- Aluminum Layer Burglar Small, double layer (6+6 mm) in aluminum frame
- Light opening: 578,5 x 146,5 mm
- Burglar Resistance Class 2

### 2.4.6 Protective grating

To discourage burglars to use the windows as a way in, protective window grating can be installed on the inside of the door. Standard delivery is dull black. Other colors available on request. The protective window grating measures 750 mm width. The height depends on the height of the section.



### 2.4.7 Frame section

The Dynaco I-14DD overhead sectional direct drive door can be fitted with a Dynaco OH1042F frame section. The height of this section is 545mm. Please refer to the relevant documentation for details.



### 2.4.8 Number of windows

For windows and passdoors, the daylight width is divided into a fixed grid. The number of windows depends on the daylight width of the door and the presence of a passdoor.

#### Windows

No. of windows	Daylight width (without Passdoor)	Daylight width (with Passdoor)
1	2050 - 2134 mm	2050 - 2339 mm
2	2135 - 2999 mm	2340 - 3304 mm
3	3000 - 3864 mm	3305 - 4269 mm
4	3865 - 4729 mm	4270 - 5234 mm
5	4730 - 5594 mm	5235 - 6050 mm
6	5595 - 6459 mm	-
7	6460 - 7324 mm	-
8	7325 - 8000 mm	-

Optional: One window in the outer left or right side of section 3 only.

### 2.4.9 Windows

#### Without Passdoor

##### DARP/TARP/ALRB/ALBS

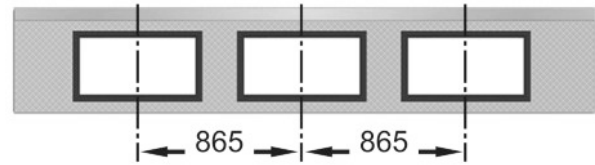

##### DAOP

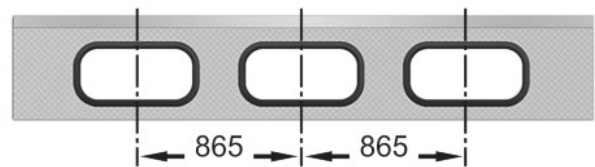

#### With Passdoor

##### DARP/TARP/ALRB/ALBS

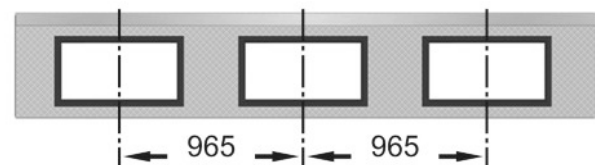

##### DAOP

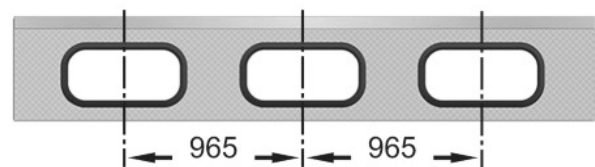



## 2.5 Optional colors\*

### Factory painting

The door leaf can be factory painted in any RAL and NCS color plus some metallic colors, outside only. The painting can be applied to only the panel or to the complete door leaf, including frames and strips.

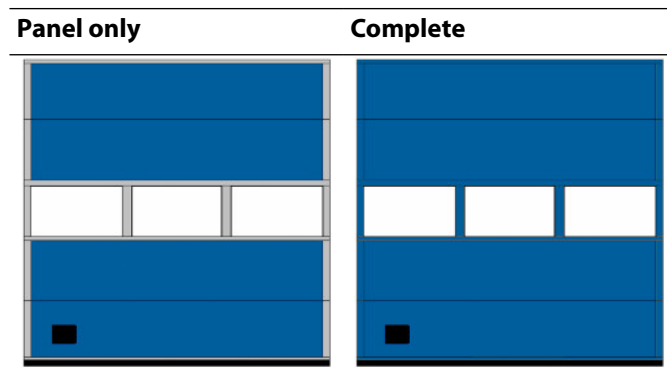

\* Other colors available on request

## 2.6 Locks

### 2.6.1 Cylinder lock

The Cylinder lock is a key operated lock which offers extra security. The lock is installed on the inside and can be unlocked with a key and turning the handle. Access to the Cylinder lock is possible from either only the inside, or both the inside and the outside.



## 2.7 Anti corrosive hardware

For use under harsh conditions the Dynaco I-14DD overhead sectional direct drive door can be fitted with a set of anti corrosive hardware. There are 2 sets available to cope with the different demands.

### Set Corrosive C

Roller brackets	Stainless steel
Rollers	Stainless steel
Clamp	Stainless steel
Hinges, Joining plate	Plastic
Screws	Anti-corrosion treated
Corner bracket	Powder coated
Door cables 3-5 mm	Stainless steel

### Set Corrosive A

All options in Set Corrosive C plus:

End caps	Powder coated
Top section brackets	Powder coated
Trusses	Powder coated
Track set	Powder coated
Buffers	Powder coated
Safety pull device	Powder coated
Screw/bolt set	Anti-corrosion treated

Recommended for wet environments like Carwash.

The anti corrosive hardware sets are available for the track types SL, HL and VL.

For technical reasons some parts are not available in an anti corrosive version.

## 2.8 Collision protection

### 2.8.1 Track protection kit

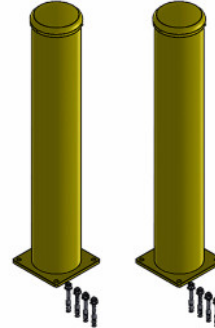

The track protection kit is designed to protect the tracks being accidentally hit by vehicles. The kit includes two bollards and fasteners. The bollards are powder coated with a UV protective paint and the top can be removed to fill the bollard with sand or concrete. The bollards are 1000 mm high with a diameter and thickness of 159×3 mm and the plate is 200 mm square. The distance between (any part of) the door and the bollards should be at least 500 mm to prevent people from getting stuck between the bollards and the door.

### 2.8.2 Reinforced bottom profile

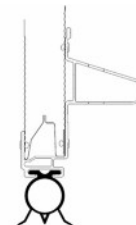

A special aluminium bottom profile with an integrated reinforcement is available if extra collision protection is needed.

## 3 Operating system

### 3.1 Type of operation

An Dynaco I-14DD overhead sectional direct drive door is always electrically operated. If needed the door can be opened and closed by chain hoist. Electrically operated doors can be controlled by hand or be fully automatic.

### 3.2 Electrical operation

The Dynaco I-14DD overhead sectional direct drive door will be supplied with a high performance electrical operating system. This operating system gives access to the full program of Access and Automation functions, that can fulfill many operational needs, related to traffic type and frequency, door weight and temperature control.

### 3.3 TS 971XL Door control

The TS 971XL door control system is an advanced control unit that is prepared for upgrades from the range of automation systems. An automation system allows door operation by sensors or remote control.

The TS 971XL control unit contains a diagnostics display that allows efficient troubleshooting and displays the number of door cycles. This extra feature allows advanced maintenance planning to users where the door is an essential element of internal logistics.



- Dimensions: 300 x 400 x 165 mm (wxhxd)
- Standard actuator UP-STOP-DOWN and pulse control
- Automatic closing after set period 0-240s.

### 3.4 SI 16.20-SW32,1 Operator

A main part of the system is the SI 16.20-SW32,1 operator: an electric motor which drives the shaft with the cable drums. The SI 16.20-SW32,1 operator is mounted directly on the shaft and does not require any special wall reinforcement.

Key features:

- Smooth and silent
- Shaft: HEX

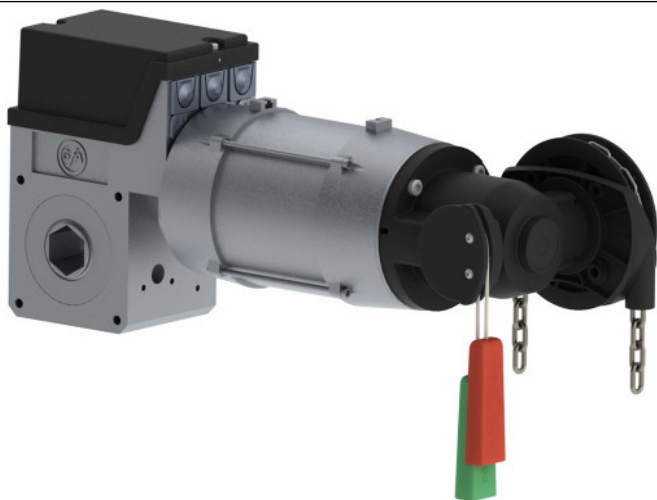

#### SI 16.20-SW32,1 Operator

<b>Voltage supply:</b>	400V AC, +/- 10% 3-phase 50/60Hz, 10A
<b>Power:</b>	0,95 kW
<b>Degree of protection:</b>	IP65, with CEE plug, IP 54
<b>Allowed door weight, max.:</b>	200 kg
<b>Temperature working range:</b>	-10°C to +60°C*
<b>Operating factor:</b>	ED = 30% S3 10 min. intermittent (≈ 30 cycles/hour)

\* If temperature range is +40°C to +60°C use half of maximum movements per hour, meaning max ED = 15%.

### 3.5 Guidelines for automation

The "Automation F-kits" are packages of common combinations. These kits can also be supplemented by "additions to F-kits".

Automation F-kits	F1	F2	F4
Magnetic loop		<input type="checkbox"/>	<input type="checkbox"/>
Warning lights - Red	<input type="checkbox"/>		<input type="checkbox"/>
<b>Additions to F-kits</b>			
Warning lights - Green	<input type="checkbox"/>	<input type="checkbox"/>	<input type="checkbox"/>
Relay box			
Radar	<input type="checkbox"/>	<input type="checkbox"/>	<input type="checkbox"/>

Standard  Option / Available

## 3.6 Access and automation

Dynaco offers a wide range of functions that allows advanced opening and safety control. Please refer to the specification sheet of the control units to see which functions apply to which models.

### 3.6.1 Basic control functions

#### 3.6.1.1 Reduced opening

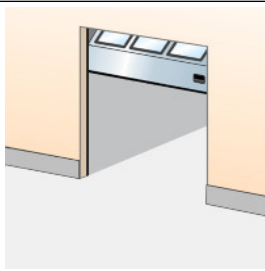

When it is unnecessary or undesirable to fully open a door, an additional switch can be used to open the door to a pre-programmed reduced opening position.

### 3.6.2 External control functions

#### 3.6.2.1 External push button box

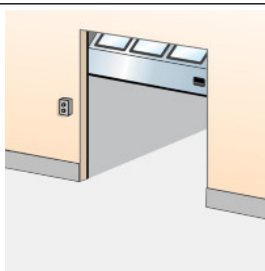

An extra control box is installed outside the building or inside close to the door if the main control unit needs to be installed away from the door opening. Installed on the inside or outside wall beside the door.

#### 3.6.2.2 Pull-rope switch

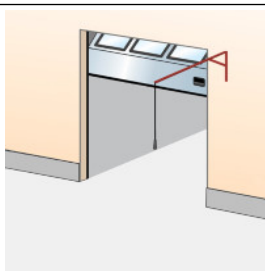

A pull-rope switch above the door opening can be operated from e.g. a forklift truck. Pulling the rope opens a closed door or closes an opened door. Installed on the inside construction above the door.

### 3.6.3

#### 3.6.3.1 Remote control

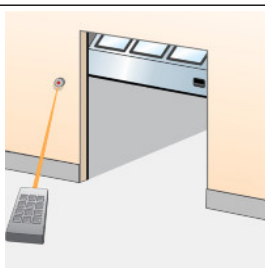

A hand-held radio transmitter allows door operation from a vehicle or any position within 50-100 meters from the receiver and aerial at the door. For closing, the door can be provided with a photocell beam.

#### 3.6.3.2

Receiver installed in control unit, antenna installed on the wall beside the door.

### Automatic control functions

#### Magnetic loop

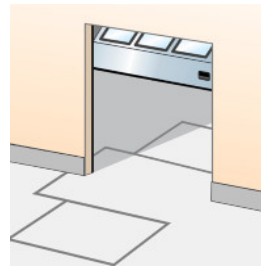

A sensor in the floor detects a metal object (usually forklift trucks, pallet trucks) and opens the door automatically. This is an ideal solution for frequent vehicle traffic. Installed on the outside, inside or both sides of the door in the floor.

#### Radar

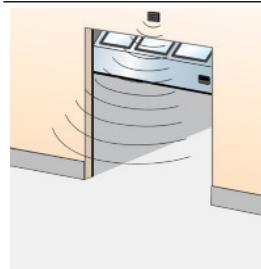

An infrared sensor above the door detects an object (person, vehicle) within a specified distance from the door and opens the door automatically. This is an ideal solution for frequent vehicle or personal traffic. Often combined with automatic closing. Installed on the inside or outside wall above the door.

#### Photocell open door

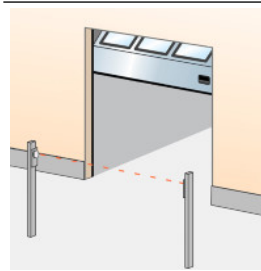

A set of photocells on pillars, on each side of the door. When a person or vehicle passes between the photocells, the beam is interrupted and the door opens. Photocells installed on pillars, away from the door.

#### Automatic closing

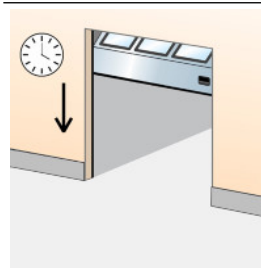

A programmable timer that closes the door after a specified time, counted from either the fully open position and/or from passing through the photocell beam. Adjustable micro switches in control unit.

## Safety functions

### 3.6.4.1 Safety edge

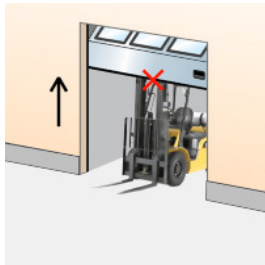

As a standard, all doors that have the impulse-close function or any form of automated closing, are equipped with a safety edge. The pneumatic sensor in the bottom seal detects any obstruction under a closing door and reverses the door.

Installed in the bottom seal.

### 3.6.4.2 Safety photocells 1-channel

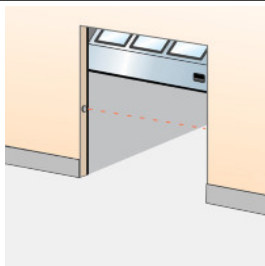

A set of a photocell transmitter and receiver is installed in the door opening. If the photocell beam is interrupted during closing, the door will stop and reverse to the fully open position.

Installed in the door opening.

### 3.6.4.3 Safety photocells 2-channel

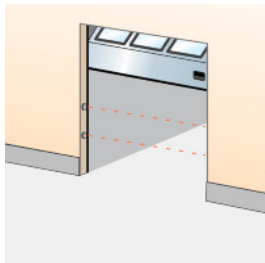

Two sets of photocell transmitter and receiver are installed in the door opening. If one or both photocell beams are interrupted during closing, the door will stop and reverse to the fully open position.

Installed in the door opening.

### 3.6.4.4 Warning lights - Red

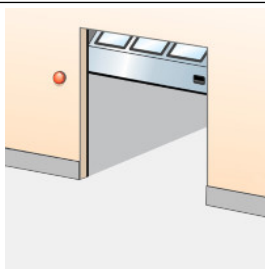

Two red warning lights giving information on the current door behaviour. Flashing light before or during door movement.

Optional: Continuous light before and during door movement.

Installed on the inside and outside wall beside the door.

### 3.6.4.5 Warning lights - Green

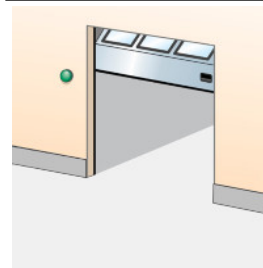

One or two green warning lights indicating the open position of the door by continuous light signal.

Installed on the inside and/or outside wall beside the door.

### 3.6.4.6 Traffic lights - Red & Green

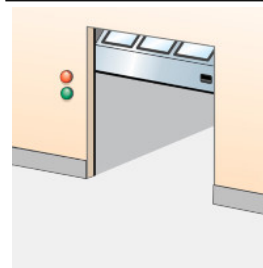

A combination of Warning lights - Red and Warning lights - Green.

Installed on the inside and outside wall beside the door.

## 3.6.5 Additional functions

### 3.6.5.1 Light curtain

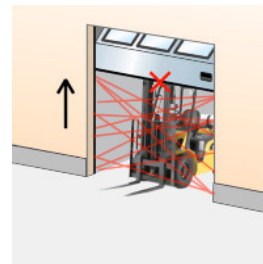

The speed door is standard equipped with a light curtain. These strips of photocells in the tracks detect any obstruction under a closing door and reverse the door.

### 3.6.5.2 UPS battery backup



When mains failure cannot be permitted or an increased risk of mains failure is predicted, the UPS battery backup system can be installed to store enough energy for 5 door cycles.

Installed on the inside wall beside the door.

## 4 CEN Performance

### 4.1 Lifetime expectation

Door: 200000 door cycles or 10 years, when service/replacement program has been performed  
Motor: 50000 door cycles

### 4.2 Resistance to windload

EN12424		
Test result		Class 3
Class	Pressure Pa (N/m <sup>2</sup> )	Specification
0	-	No performance determined
1	300	
2	450	
3	700	
4	1000	
5	> 1000	Exceptional : Agreement between manufacturer and supplier

### 4.3 Resistance to water penetration

EN12425		
Test result		Class 3
Class	Pressure Pa (N/m <sup>2</sup> )	Specification
0	-	No performance determined
1	30	Waterspray for 15 minutes
2	50	Waterspray for 20 minutes
3	> 50	Exceptional : Agreement between manufacturer and supplier

### 4.4 Air permeability

EN12426	
Test result	Class 3
Class	Air permeability dp at a pressure of 50 Pa (m <sup>3</sup> /m <sup>2</sup> /h)
0	-
1	24
2	12
3	6
4	3
5	1,5
6	Exceptional : Agreement between manufacturer and supplier

## 4.5 Thermal transmittance

### EN12428

Thermal transmittance	1,1 W/(m <sup>2</sup> K) full panel (Door size 4050 x 4250 mm)
	1,0 W/(m <sup>2</sup> K) full panel (Door size 5000 x 5000 mm)

## 4.6 Acoustic insulation

### ISO 10140-2

Acoustic insulation *	R - 25 dB
-----------------------	-----------

\* Door surface 4000 x 2500 mm, no passdoor (for other sizes it can differ)

## 4.7 Operating forces and safe openings

EN12453 & EN12604	Crushing force N	Crushing force N	Crushing force N
Opening gap mm	200 mm from lateral border right from outside	In the middle of the door opening	200 mm from lateral border left from outside
50 mm	passed	passed	passed
300 mm	passed	passed	passed

The crushing force is the force needed for the safety edge to be activated. The maximum force allowed, according to EN12453 safety in use of power operated doors is 400 N within a maximum period of time of 0.75s. With standard light curtain there is no crushing force.



# 5 Building and space requirements

## 5.1 Building preparations

### 5.1.1 Installation preparations

The Dynaco I-14DD overhead sectional direct drive door is shipped in parts and installed on-site. All necessary installation material is included. For every track type Dynaco offers specific installation kits to position the door in the building facade.

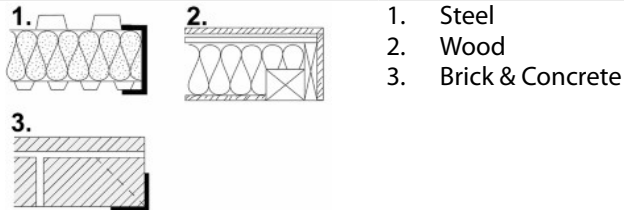

## 5.2 Space requirements

DLH	= Daylight Height	The height of the clear opening
DLW	= Daylight Width	The width of the clear opening
D	= Depth	The space between the inner side of the wall and the end of the horizontal track construction
h	= Excess height	The extra space required above the daylight height.
SL	= Side space Left	The space required for tracks beside the daylight width.
SR	= Side space Right	The space required for tracks beside the daylight width.

The grey marked area in the illustrations shows the free space required by door movement. Extra space requirements for electrically operated doors are stated in the operator specifications.

### 5.2.1 Space requirements SL

DLW	≤ 4050 mm
DLH	≤ 4250 mm
h	488 mm
SL/SR	135 mm, 277 mm on operator side
D	DLH + 600 mm

For details see the specific building preparation drawings.

#### Side and top view

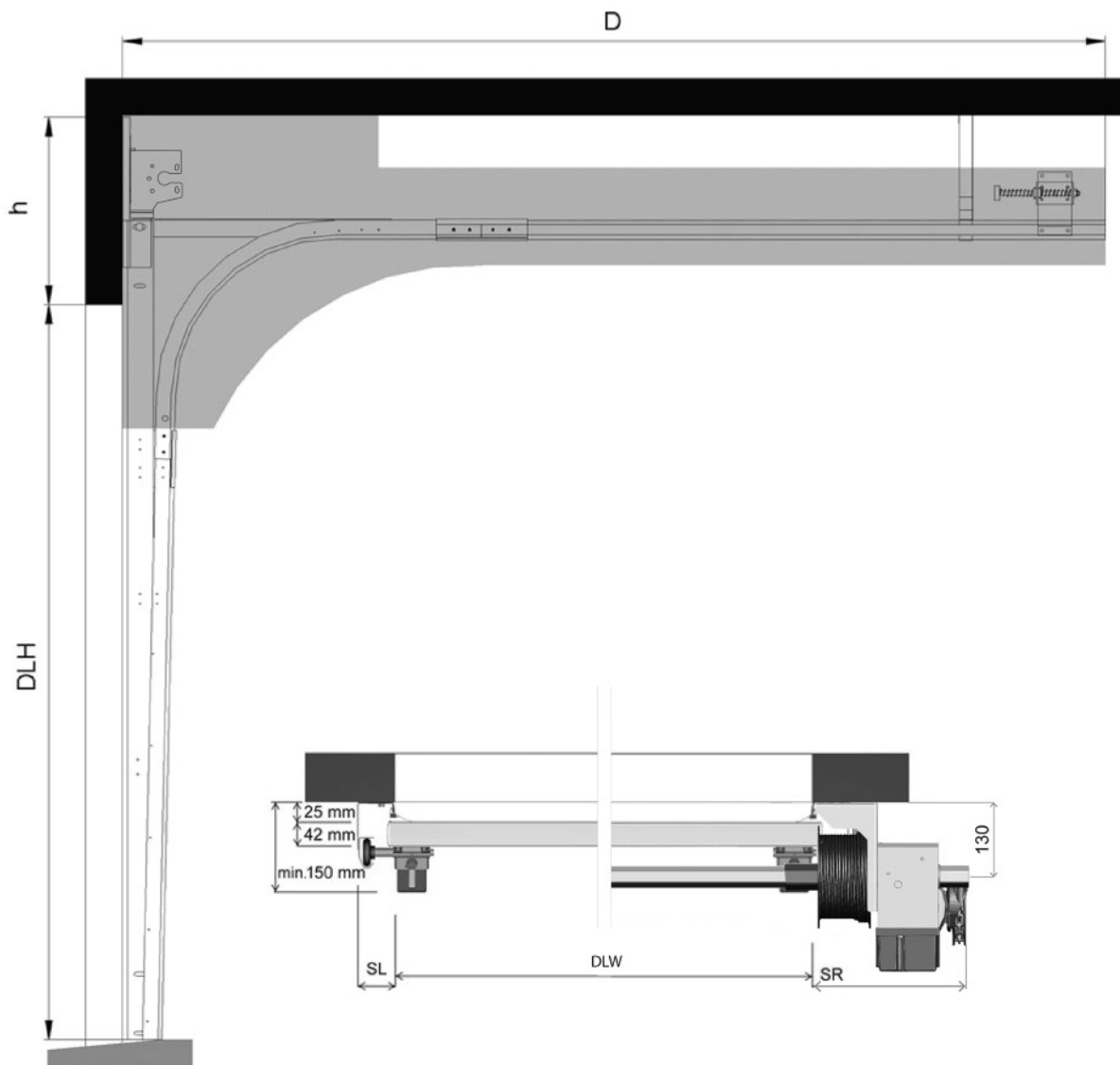

### 5.2.2 Space requirements HL

DLW	≤ 4050 mm
DLH	≤ 4250 mm
h	HL+310 mm
SL/SR	135 mm, 277 mm on operator side
D	DLH - HL + 950 mm

We would advise the following doors to be installed on a frame, equipped with an A-65 top seal.

- Doors DLW ≥ 4050 mm with a dark outside colour, frequently exposed to solar heat.  
For details see the specific building preparation drawings.

#### Side and top view

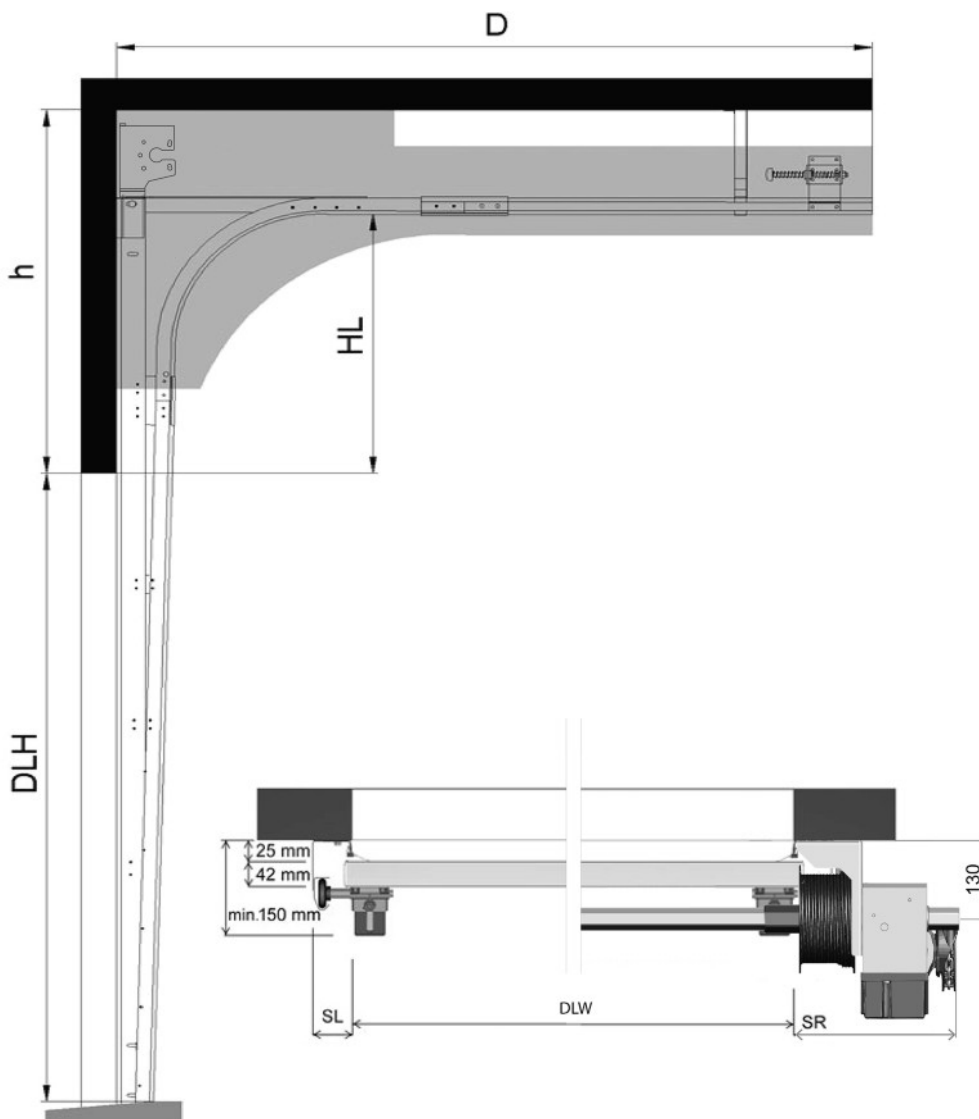

### 5.2.3 Space requirements VL

DLW	≤ 4050 mm
DLH	≤ 4250 mm
h	DLH + 400 mm
SL/SR	135 mm, 277 mm on operator side
D	VLU = 295 mm

We would advise the following doors to be installed on a frame, equipped with an A-65 top seal.

- Doors DLW ≥ 4050 mm with a dark outside colour, frequently exposed to solar heat.  
For details see the specific building preparation drawings.

#### Side and top view

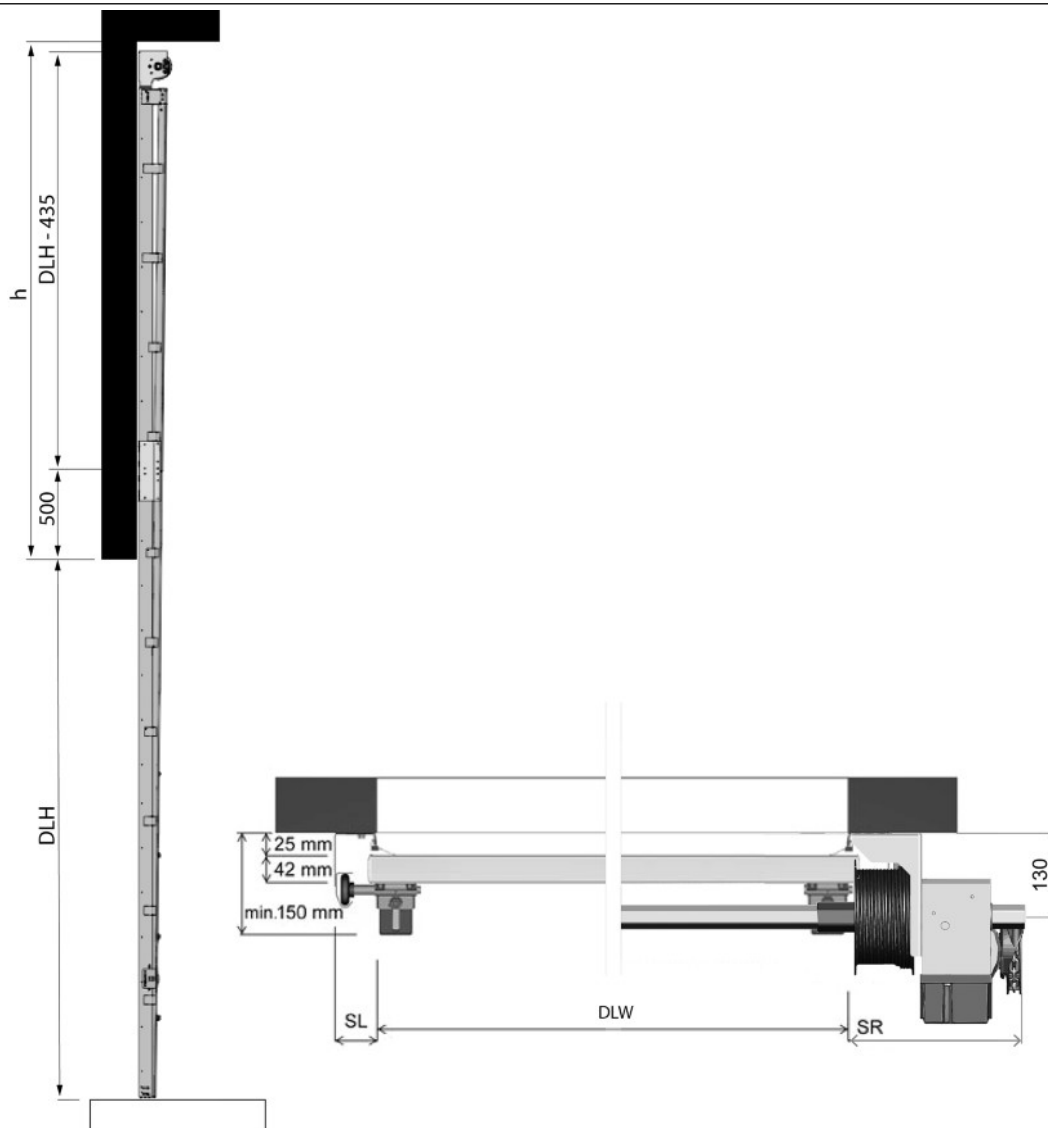

## 5.2.4 Space requirements Door operators

### 5.2.4.1 I-14DD Installation locations

#### Location of I-14DD operator

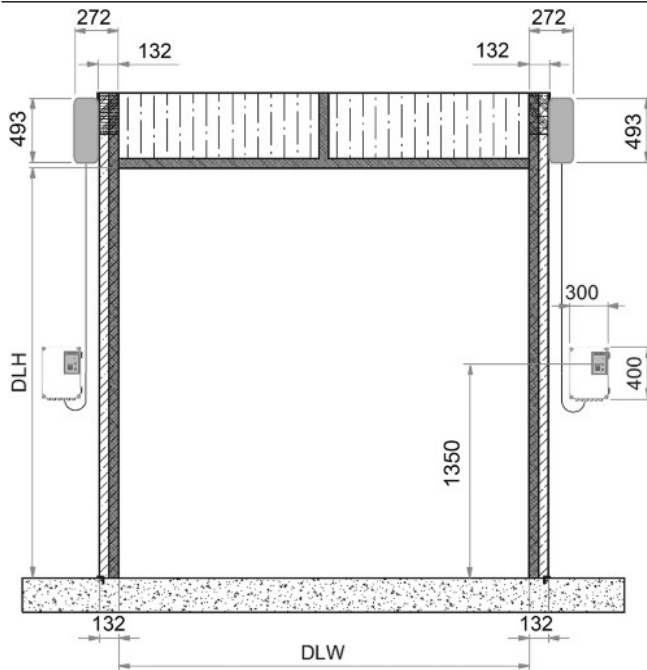

# Index

## A

Access and automation.....	21
Acoustic insulation.....	24
Additional functions.....	22
Air permeability.....	23
ALBS.....	15
ALRB.....	15
Anti corrosive hardware.....	18
Automatic closing.....	21
Automatic control functions.....	21
Available Options.....	12

## B

Basic control functions.....	21
Bottom seal.....	9
Building and space requirements	25
Building preparations.....	25

## C

CEN Performance.....	23
Collision protection.....	18
Colors.....	8
Construction.....	7
Copyright and Disclaimer Notice..	2
Cylinder lock.....	17

## D

DAOP.....	15
DARP.....	14
Daylight width and daylight height	
.....	6
Description.....	6
Dimensions.....	6
Door leaf.....	7

## E

Electrical operation.....	19
External control functions.....	21
External push button box.....	21

## F

Features.....	3
Fixed sections.....	13
Fixed sections options.....	13
Frame section.....	15

## G

General.....	6
General.....	10
Guidelines for automation.....	20

## H

Handle.....	10
HL - High Lift.....	11

## I

I-14DD Installation locations.....	29
Installation preparations.....	25

## L

Lifetime expectation.....	23
Light curtain.....	22
Lock bolt.....	10
Locks.....	17

## M

Magnetic loop.....	21
Material.....	7

## N

Number of windows.....	16
------------------------	----

## O

Operating forces and safe openings	
.....	24
Operating system.....	19
Optional colors*.....	17

## P

Passdoor standard threshold	
(180mm).....	13
Passdoor with standard threshold	
(180 mm).....	12
Performance.....	3
Photocell open door.....	21
Pre-coated colors.....	8
Protective grating.....	15
Pull-rope switch.....	21

## R

Radar.....	21
Reduced opening.....	21
Reinforced bottom profile.....	18
Remote control.....	21
Resistance to water penetration..	23
Resistance to windload.....	23

## S

Safety edge.....	22
Safety functions.....	22
Safety photocells 1-channel.....	22
Safety photocells 2-channel.....	22
Seals.....	9
Section sizes.....	6
SI 16.20-SW32,1 Operator.....	20
Side seal.....	9
SL - Standard Lift.....	10
Space requirements.....	25
Space requirements Door operators	
.....	29
Space requirements HL.....	27
Space requirements SL.....	26
Space requirements VL.....	28

## T

TARP.....	14
Technical Overview.....	3
Thermal transmittance.....	24
Top seal.....	9
Track protection kit.....	18
Track sets.....	10
Traffic lights - Red & Green.....	22
TS 971XL Door control.....	19
Type of operation.....	19

## U

UPS battery backup.....	22
-------------------------	----

## V

Vertical cross-section.....	8
VL - Vertical Lift.....	11

**W**

Warning lights - Green.....	22
Warning lights - Red.....	22
Wind reinforcement truss.....	9
Windows.....	14, 16



DYNACO EUROPE NV  
Waverstraat 21  
B-9310 Moorsel-Aalst (Belgium)  
Tel. +32 53 72 98 98  
Fax. +32 53 72 98 50

Info@dynacodoor.com www.dynacodoor.com

#### About Dynaco

Dynaco is the world leader in high-speed door technology. It offers state of the art solutions for both commercial and industrial applications.

Founded in 1987, Dynaco has acquired an extensive expertise in high performance doors. Yet it continues to invest in order to exceed your expectations of quality and performance. A network of certified and dedicated partners ensures an optimal service to customers all over Europe.

Worldwide, we rely on our license partners in Russia, Japan, Vietnam and Brazil.

Dynaco is part of the ASSA ABLOY Group, the world leader in access solutions. Every day, we help billions of people experience a more open world.